

DDR4 SDRAM Memory

Product Guide

SAMSUNG ELECTRONICS RESERVES THE RIGHT TO CHANGE PRODUCTS, INFORMATION AND SPECIFICATIONS WITHOUT NOTICE.

Products and specifications discussed herein are for reference purposes only. All information discussed herein is provided on an "AS IS" basis, without warranties of any kind.

This document and all information discussed herein remain the sole and exclusive property of Samsung Electronics. No license of any patent, copyright, mask work, trademark or any other intellectual property right is granted by one party to the other party under this document, by implication, estoppel or otherwise.

Samsung products are not intended for use in life support, critical care, medical, safety equipment, or similar applications where product failure could result in loss of life or personal or physical harm, or any military or defense application, or any governmental procurement to which special terms or provisions may apply.

For updates or additional information about Samsung products, contact your nearest Samsung office.

All brand names, trademarks and registered trademarks belong to their respective owners.

1. DDR4 SDRAM MEMORY ORDERING INFORMATION

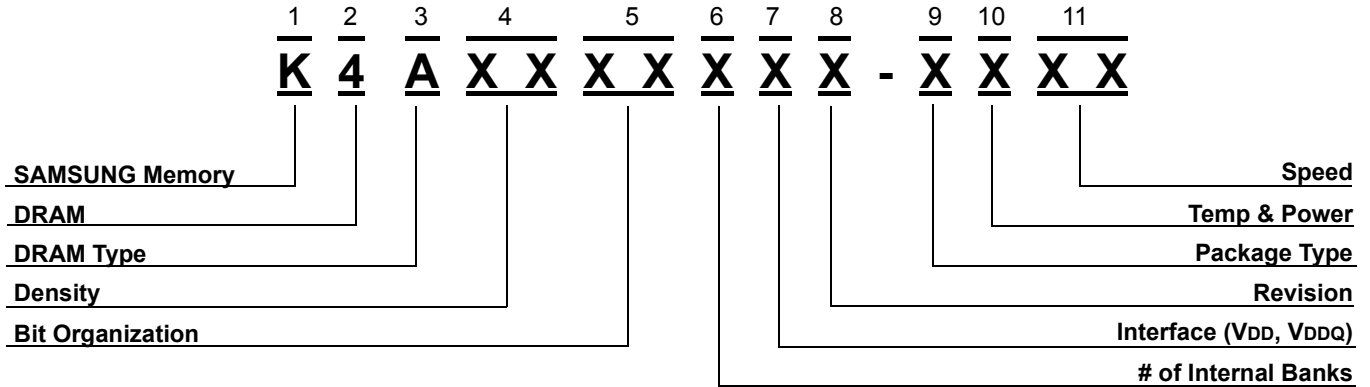

1. SAMSUNG Memory : K

2. DRAM : 4

3. DRAM Type

A : DDR4 SDRAM (1.2V VDD)

4. Density

- 4G : 4Gb
- 8G : 8Gb
- AG : 16Gb
- BG : 32Gb

5. Bit Organization

- 04 : x 4
- 08 : x 8
- 16 : x16

6. # of Internal Banks

5 : 16 Banks

7. Interface (VDD, VDDQ)

W : POD (1.2V, 1.2V)

8. Revision

- M : 1st Gen.
- A : 2nd Gen.
- B : 3rd Gen.
- C : 4th Gen.
- D : 5th Gen.
- E : 6th Gen.
- F : 7th Gen.
- G : 8th Gen.

9. Package Type

- B : FBGA (Halogen-free & Lead-free, Flip Chip)
- M : FBGA (Halogen-free & Lead-free, DDP)
- 2 : FBGA (Halogen-free & Lead-free, 2H TSV)
- 4 : FBGA (Halogen-free & Lead-free, 4H TSV)

10. Temp & Power

- C : Commercial Temp.(0°C ~ 85°C) & Normal Power
- I : Industrial Temp.(-40°C ~ 95°C) & Normal Power

11. Speed

- PB : DDR4-2133 (1066MHz @ CL=15, tRCD=15, tRP=15)
- RC : DDR4-2400 (1200MHz @ CL=17, tRCD=17, tRP=17)
- TD : DDR4-2666 (1333MHz @ CL=19, tRCD=19, tRP=19)
- RB : DDR4-2133 (1066MHz @ CL=17, tRCD=15, tRP=15)
- TC : DDR4-2400 (1200MHz @ CL=19, tRCD=17, tRP=17)
- WD : DDR4-2666 (1333MHz @ CL=22, tRCD=19, tRP=19)

2. DDR4 SDRAM Component Product Guide

Density	Banks	Part Number	Package & Power, Temp. & Speed	Org.	VDD Voltage	PKG	Avail.	NOTE
4Gb D-die	16Banks (4Bank Groups)	K4A4G045WD	BCPB/RC	1G x 4	1.2V	78 ball FBGA	MP	
		K4A4G085WD	BCPB/RC	512M x 8				
	8Banks (2Bank Groups)	K4A4G165WD	BCPB/RC	256M x 16	1.2V	96 ball FBGA		
4Gb E-die	16Banks (4Bank Groups)	K4A4G045WE	BCPB/RC/TD ¹⁾	1G x 4	1.2V	78 ball FBGA	MP	
		K4A4G085WE	BCPB/RC/TD ¹⁾	512M x 8				
	8Banks (2Bank Groups)	K4A4G165WE	BCPB/RC/TD ¹⁾	256M x 16	1.2V	96 ball FBGA		
8Gb B-die	16Banks (4Bank Groups)	K4A8G045WB	BCPB/RC/TD ¹⁾	2G x 4	1.2V	78 ball FBGA	MP	
		K4A8G085WB	BCPB/RC/TD ¹⁾	1G x 8				
	8Banks (2Bank Groups)	K4A8G165WB	BCPB/RC/TD ¹⁾	512M x 16	1.2V	96 ball FBGA		
8Gb C-die	16Banks (4Bank Groups)	K4A8G045WC	BCRC/TD ¹⁾	2G x 4	1.2V	78 ball FBGA	CS '16 4Q	
		K4A8G085WC	BCRC/TD ¹⁾	1G x 8				
	8Banks (2Bank Groups)	K4A8G165WC	BCRC/TD ¹⁾	512M x 16	1.2V	96 ball FBGA		

NOTE:

1) Need to contact SAMSUNG for TD (2666Mbps) availability

3. DDR4 SDRAM Module Ordering Information

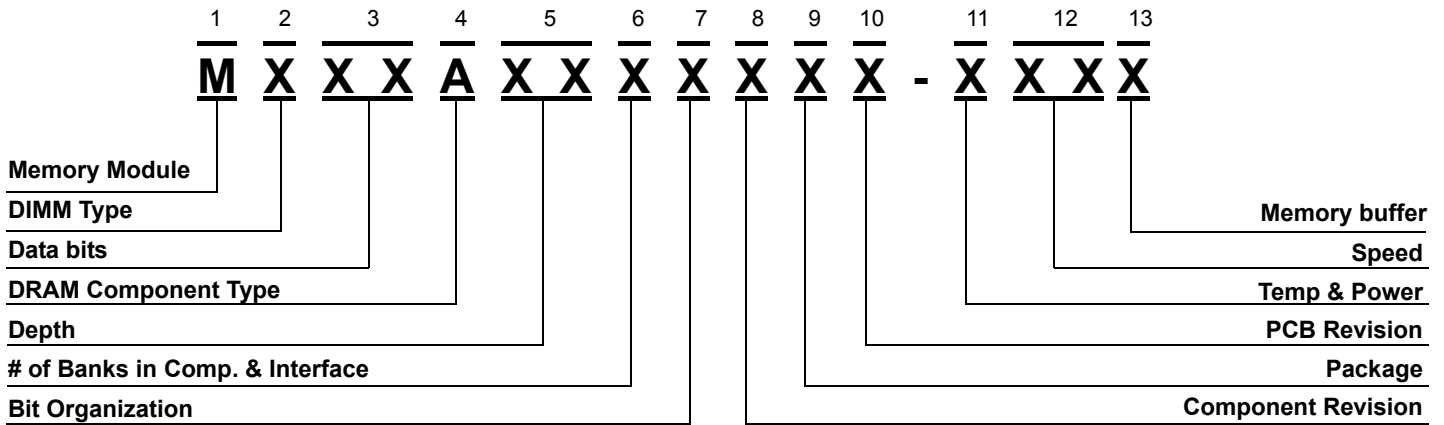

1. Memory Module : M

2. DIMM Type

- 3 : DIMM
- 4 : SODIMM

3. Data Bits

- 71: x64 260pin Unbuffered SODIMM
- 74: x72 260pin ECC Unbuffered SODIMM
- 78: x64 288pin Unbuffered DIMM
- 86: x72 288pin Load Reduced DIMM
- 91: x72 288pin ECC Unbuffered DIMM
- 92: x72 288pin VLP Registered DIMM
- 93: x72 288pin Registered DIMM

4. DRAM Component Type

- A : DDR4 SDRAM (1.2V VDD)

5. Depth

- 56 : 256M AG : 16G
- 51 : 512M 1K : 1G (for 8Gb)
- 1G : 1G 2K : 2G (for 8Gb)
- 2G : 2G 4K : 4G (for 8Gb)
- 4G : 4G 8K : 8G (for 8Gb)
- 8G : 8G AK : 16G

6. # of Banks in comp. & Interface

- 4 : 16Banks & POD-1.2V

7. Bit Organization

- 0 : x 4
- 3 : x 8
- 4 : x 16

8. Component Revision

- M : 1st Gen. A : 2nd Gen.
- B : 3rd Gen. C : 4th Gen.
- D : 5th Gen. E : 6th Gen.
- F : 7th Gen. G : 8th Gen.

9. Package

- B : FBGA (Halogen-free & Lead-free, Flip Chip)
- M : FBGA (Halogen-free & Lead-free, DDP)
- 2 : FBGA (Halogen-free & Lead-free, 2H TSV)
- 4 : FBGA (Halogen-free & Lead-free, 4H TSV)

10. PCB Revision

- 0 : None 1 : 1st Rev.
- 2 : 2nd Rev. 3 : 3rd Rev.
- 4 : 4th Rev.

11. Temp & Power

- C : Commercial Temp.(0°C ~ 85°C) & Normal Power

12. Speed

- PB : DDR4-2133 (1066MHz @ CL=15, tRCD=15, tRP=15)
- RC : DDR4-2400 (1200MHz @ CL=17, tRCD=17, tRP=17)
- TD : DDR4-2666 (1333MHz @ CL=19, tRCD=19, tRP=19)
- RB : DDR4-2133 (1066MHz @ CL=17, tRCD=15, tRP=15)
- TC : DDR4-2400 (1200MHz @ CL=19, tRCD=17, tRP=17)
- WD : DDR4-2666 (1333MHz @ CL=22, tRCD=19, tRP=19)

4. DDR4 SDRAM Module Product Guide

4.1 288Pin DDR4 Registered DIMM

288Pin DDR4 Registered DIMM													
Org.	Density	Part Number	Temp & Power & Speed	Raw Card	Composition	Comp. Version		Internal Banks	Rank	PKG	Height	Avail.	NOTE
512G x 72	4GB	M393A5143DB0	CPB	D (1Rx8)	512M x8 * 9pcs	4Gb	D-die	16	1	78ball FBGA	31.25mm	EOL 4Q'17	
512G x 72	4GB	M393A5143DB0	CRC	D (1Rx8)	512M x8 * 9pcs	4Gb	D-die	16	1	78ball FBGA	31.25mm	EOL 4Q'17	
1G x 72	8GB	M393A1G40DB0	CPB	C (1Rx4)	1G x4 * 18pcs	4Gb	D-die	16	1	78ball FBGA	31.25mm	EOL 3Q'17	
1G x 72	8GB	M393A1G40DB1	CRC	C (1Rx4)	1G x4 * 18pcs	4Gb	D-die	16	1	78ball FBGA	31.25mm	EOL 3Q'17	
1G x 72	8GB	M393A1G43DB0	CPB	E (2Rx8)	512M x8 * 18pcs	4Gb	D-die	16	2	78ball FBGA	31.25mm	EOL 3Q'17	
1G x 72	8GB	M393A1G43DB1	CRC	E (2Rx8)	512M x8 * 18pcs	4Gb	D-die	16	2	78ball FBGA	31.25mm	EOL 3Q'17	
1G x 72	8GB	M393A1G40EB1	CPB	C (1Rx4)	1G x4 * 18pcs	4Gb	E-die	16	1	78ball FBGA	31.25mm	MP	
1G x 72	8GB	M393A1G40EB1	CRC	C (1Rx4)	1G x4 * 18pcs	4Gb	E-die	16	1	78ball FBGA	31.25mm	MP	
1G x 72	8GB	M393A1G40EB1	CTD	C (1Rx4)	1G x4 * 18pcs	4Gb	E-die	16	1	78ball FBGA	31.25mm	MP	
1G x 72	8GB	M393A1G43EB1	CPB	E (2Rx8)	512M x8 * 18pcs	4Gb	E-die	16	2	78ball FBGA	31.25mm	MP	
1G x 72	8GB	M393A1G43EB1	CRC	E (2Rx8)	512M x8 * 18pcs	4Gb	E-die	16	2	78ball FBGA	31.25mm	MP	
1G x 72	8GB	M393A1G43EB1	CTD	E (2Rx8)	512M x8 * 18pcs	4Gb	E-die	16	2	78ball FBGA	31.25mm	MP	
1G x 72	8GB	M393A1K43BB0	CPB	D (1Rx8)	1G x8 * 9pcs	8Gb	B-die	16	1	78ball FBGA	31.25mm	MP	
1G x 72	8GB	M393A1K43BB0	CRC	D (1Rx8)	1G x8 * 9pcs	8Gb	B-die	16	1	78ball FBGA	31.25mm	MP	
1G x 72	8GB	M393A1K43BB0	CTD	D (1Rx8)	1G x8 * 9pcs	8Gb	B-die	16	1	78ball FBGA	31.25mm	MP	
2G x 72	16GB	M393A2G40DB0	CPB	A (2Rx4)	1G x4 * 36pcs	4Gb	D-die	16	2	78ball FBGA	31.25mm	EOL 2Q'17	
2G x 72	16GB	M393A2G40DB1	CRC	A (2Rx4)	1G x4 * 36pcs	4Gb	D-die	16	2	78ball FBGA	31.25mm	EOL 2Q'17	
2G x 72	16GB	M393A2G40EB1	CPB	A (2Rx4)	1G x4 * 36pcs	4Gb	E-die	16	2	78ball FBGA	31.25mm	MP	
2G x 72	16GB	M393A2G40EB1	CRC	A (2Rx4)	1G x4 * 36pcs	4Gb	E-die	16	2	78ball FBGA	31.25mm	MP	
2G x 72	16GB	M393A2G40EB1	CTD	A (2Rx4)	1G x4 * 36pcs	4Gb	E-die	16	2	78ball FBGA	31.25mm	MP	
2G x 72	16GB	M393A2K40BB0	CPB	C (1Rx4)	2G x4 * 18pcs	8Gb	B-die	16	1	78ball FBGA	31.25mm	MP	
2G x 72	16GB	M393A2K40BB1	CRC	C (1Rx4)	2G x4 * 18pcs	8Gb	B-die	16	1	78ball FBGA	31.25mm	MP	
2G x 72	16GB	M393A2K40BB1	CTD	C (1Rx4)	2G x4 * 18pcs	8Gb	B-die	16	1	78ball FBGA	31.25mm	MP	
2G x 72	16GB	M393A2K43BB1	CPB	E (2Rx8)	1G x8 * 18pcs	8Gb	B-die	16	2	78ball FBGA	31.25mm	MP	
2G x 72	16GB	M393A2K43BB1	CRC	E (2Rx8)	1G x8 * 18pcs	8Gb	B-die	16	2	78ball FBGA	31.25mm	MP	

2G x72	16GB	M393A2K43BB1	CTD	E (2Rx8)	1G x8 * 18pcs	8Gb	B-die	16	2	78ball FBGA	31.25mm	MP	
4G x72	32GB	M393A4K40BB0	CPB	A (2Rx4)	2G x4 * 36pcs	8Gb	B-die	16	2	78ball FBGA	31.25mm	MP	
4G x72	32GB	M393A4K40BB1	CRC	A (2Rx4)	2G x4 * 36pcs	8Gb	B-die	16	2	78ball FBGA	31.25mm	MP	
4G x72	32GB	M393A4K40BB1	CTD	A (2Rx4)	2G x4 * 36pcs	8Gb	B-die	16	2	78ball FBGA	31.25mm	MP	
8G x72	64GB	M393A8K40B21	CRB	A (4Rx4)	2H TSV 4G x4 * 36pcs	8Gb	B-die	16	4	78ball FBGA	31.25mm	MP	
8G x72	64GB	M393A8K40B21	CTC	A (4Rx4)	2H TSV 4G x4 * 36pcs	8Gb	B-die	16	4	78ball FBGA	31.25mm	MP	
8G x 72	64GB	M393A8K40B21	CWD	A (4Rx4)	2H TSV 4G x4 * 36pcs	8Gb	B-die	16	4	78ball FBGA	31.25mm	CS 4Q'16	
16G x 72	128GB	M393AAK40B41	CTC	A (8Rx4)	4H TSV 8G x4 * 36pcs	8Gb	B-die	16	8	78ball FBGA	31.25mm	MP	
16G x 72	128GB	M393AAK40B41	CWD	A (8Rx4)	4H TSV 8G x4 * 36pcs	8Gb	B-die	16	8	78ball FBGA	31.25mm	CS 4Q'16	

4.2 288Pin DDR4 Load Reduced DIMM

288Pin DDR4 Load Reduced DIMM													
Org.	Density	Part Number	Temp & Power & Speed	Raw Card	Composition	Comp. Version		Internal Banks	Rank	PKG	Height	Avail.	NOTE
4G x72	32GB	M386A4G40DM0	CPB	D (4Rx4)	DDP 2G x4 * 36pcs	4Gb	D-die	16	4	78ball FBGA	31.25mm	EOL 4Q'17	
4G x72	32GB	M386A4G40DM1	CRC	D (4Rx4)	DDP 2G x4 * 36pcs	4Gb	D-die	16	4	78ball FBGA	31.25mm	EOL 4Q'17	
4G x72	32GB	M386A4G40EM2	CPB	D (4Rx4)	DDP 2G x4 * 36pcs	4Gb	E-die	16	4	78ball FBGA	31.25mm	CS 1Q'17	
4G x72	32GB	M386A4G40EM2	CRC	D (4Rx4)	DDP 2G x4 * 36pcs	4Gb	E-die	16	4	78ball FBGA	31.25mm	CS 1Q'17	
4G x72	32GB	M386A4K40BB0	CRC	A (2Rx4)	2G x4 * 36pcs	8Gb	B-die	16	2	78ball FBGA	31.25mm	MP	
8G x72	64GB	M386A8K40BM1	CPB	D (4Rx4)	DDP 4G x4 * 36pcs	8Gb	B-die	16	4	78ball FBGA	31.25mm	MP	
8G x72	64GB	M386A8K40BM1	CRC	D (4Rx4)	DDP 4G x4 * 36pcs	8Gb	B-die	16	4	78ball FBGA	31.25mm	MP	
8G x72	64GB	M386A8K40BM2	CTD	D (4Rx4)	DDP 4G x4 * 36pcs	8Gb	B-die	16	4	78ball FBGA	31.25mm	MP	
16G x72	128GB	M386AAK40B40	CTC	A (8Rx4)	4H TSV 8G x4 * 36pcs	8Gb	B-die	16	8	78ball FBGA	31.25mm	MP	
16G x72	128GB	M386AAK40B40	CWD	A (8Rx4)	4H TSV 8G x4 * 36pcs	8Gb	B-die	16	8	78ball FBGA	31.25mm	TBD	

4.3 288Pin DDR4 VLP Registered DIMM

288Pin DDR4 VLP Registered DIMM													
Org.	Density	Part Number	Temp & Power & Speed	Raw Card	Composition	Comp. Version		Internal Banks	Rank	PKG	Height	Avail.	NOTE
2G x72	16GB	M392A2G40DM0	CPB	J (2Rx4)	DDP 2G x4 * 18pcs	4Gb	D-die	16	2	78ball FBGA	18.75mm	EOL 4Q'17	
2G x72	16GB	M392A2K43BB0	CPB	H (2Rx8)	1G x8 * 18pcs	8Gb	B-die	16	2	78ball FBGA	18.75mm	MP	
2G x72	16GB	M392A2K43BB0	CRC	H(2Rx8)	1G x8 * 18pcs	8Gb	B-die	16	2	78ball FBGA	18.75mm	MP	
4G x72	32GB	M392A4K40BM0	CPB	J (2Rx4)	DDP 4G x4 * 18pcs	8Gb	B-die	16	2	78ball FBGA	18.75mm	MP	
4G x72	32GB	M392A4K40BM0	CRC	J (2Rx4)	DDP 4G x4 * 18pcs	8Gb	B-die	16	2	78ball FBGA	18.75mm	MP	

4.4 260Pin DDR4 ECC SODIMM

260Pin DDR4 ECC SODIMM													
Org.	Density	Part Number	Temp & Power & Speed	Raw Card	Composition	Comp. Version		Internal Banks	Rank	PKG	Height	Avail.	NOTE
1G x72	8GB	M474A1G43DB0	CPB	G (2Rx8)	512M x8 * 18pcs	4Gb	D-die	16	2	78ball FBGA	30mm	EOL 4Q'17	
1G x72	8GB	M474A1G43DB1	CRC	G (2Rx8)	512M x8 * 18pcs	4Gb	D-die	16	2	78ball FBGA	30mm	ELO 4Q'17	
1G x72	8GB	M474A1G43EB1	CPB	G (2Rx8)	512M x8 * 18pcs	4Gb	E-die	16	2	78ball FBGA	30mm	MP	
1G x72	8GB	M474A1G43EB1	CRC	G (2Rx8)	512M x8 * 18pcs	4Gb	E-die	16	2	78ball FBGA	30mm	MP	
1G x72	8GB	M474A1G43EB1	CTD	G (2Rx8)	512M x8 * 18pcs	4Gb	E-die	16	2	78ball FBGA	30mm	TBD	
2G x72	16GB	M474A2K43BB1	CPB	G (2Rx8)	1G x8 * 18pcs	8Gb	B-die	16	2	78ball FBGA	30mm	MP	
2G x72	16GB	M474A2K43BB1	CRC	G (2Rx8)	1G x8 * 18pcs	8Gb	B-die	16	2	78ball FBGA	30mm	MP	
2G x72	16GB	M474A2K43BB1	CTD	G (2Rx8)	1G x8 * 18pcs	8Gb	B-die	16	2	78ball FBGA	30mm	TBD	

4.5 260Pin DDR4 Non ECC SODIMM

260Pin DDR4 Non ECC SODIMM													
Org.	Density	Part Number	Temp & Power & Speed	Raw Card	Composition	Comp. Version		Internal Banks	Rank	PKG	Height	Avail.	NOTE
256M x64	2GB	M471A5644EB0	CPB	A (1Rx16)	256M x16 * 4pcs	4Gb	E-die	16	1	96ball FBGA	30mm	EOL 1Q'18	
256M x64	2GB	M471A5644EB0	CRC	A(1Rx16)	256M x16 * 4pcs	4Gb	E-die	16	1	96ball FBGA	30mm	EOL 1Q'18	
512M x64	4GB	M471A5143DB0	CPB	A (1Rx8)	512M x8 * 8pcs	4Gb	D-die	16	1	78ball FBGA	30mm	EOL 1Q'17	
512M x64	4GB	M471A5143EB0	CPB	A (1Rx8)	512M x8 * 8pcs	4Gb	E-die	16	1	78ball FBGA	30mm	MP	
512M x64	4GB	M471A5143EB1	CRC	A (1Rx8)	512M x8 * 8pcs	4Gb	E-die	16	1	78ball FBGA	30mm	MP	
512M x64	4GB	M471A5244BB0	CPB	A (1Rx16)	512M x16 * 8pcs	8Gb	B-die	16	1	78ball FBGA	30mm	MP	
512M x64	4GB	M471A5244BB0	CRC	A (1Rx16)	512M x16 * 8pcs	8Gb	B-die	16	1	78ball FBGA	30mm	MP	
512M x64	4GB	M471A5244BB0	CTD	A (1Rx16)	512M x16 * 8pcs	8Gb	B-die	16	1	78ball FBGA	30mm	MP	
512M x64	4GB	M471A5244CB0	CRC	A (1Rx16)	512M x16 * 8pcs	8Gb	C-die	16	1	78ball FBGA	30mm	MP	
512M x64	4GB	M471A5244CB0	CTD	A (1Rx16)	512M x16 * 8pcs	8Gb	C-die	16	1	78ball FBGA	30mm	MP	
1G x64	8GB	M471A1G43DB0	CPB	E (2Rx8)	512M x8 * 16pcs	4Gb	D-die	16	2	78ball FBGA	30mm	MP	
1G x 64	8GB	M471A1G43EB1	CPB	E (2Rx8)	512M x8 * 16pcs	4Gb	E-die	16	2	78ball FBGA	30mm	MP	
1G x 64	8GB	M471A1G43EB1	CRC	E (2Rx8)	512M x8 * 16pcs	4Gb	E-die	16	2	78ball FBGA	30mm	MP	
1G x 64	8GB	M471A1K43BB0	CPB	A (1Rx8)	1G x8 * 8pcs	8Gb	B-die	16	1	78ball FBGA	30mm	MP	
1G x 64	8GB	M471A1K43BB1	CRC	A (1Rx8)	1G x8 * 8pcs	8Gb	B-die	16	1	78ball FBGA	30mm	MP	
1G x 64	8GB	M471A1K43BB1	CTD	A (1Rx16)	1G x16 * 8pcs	8Gb	B-die	16	1	78ball FBGA	30mm	MP	
1G x 64	8GB	M471A1K43CB1	CRC	A (1Rx16)	1G x16 * 8pcs	8Gb	C-die	16	1	78ball FBGA	30mm	MP	
1G x 64	8GB	M471A1K43CB1	CTD	A (1Rx16)	1G x16 * 8pcs	8Gb	C-die	16	1	78ball FBGA	30mm	MP	
2G x 64	16GB	M471A2K43BB1	CPB	E (2Rx8)	1G x8 * 16pcs	8Gb	B-die	16	2	78ball FBGA	30mm	MP	
2G x 64	16GB	M471A2K43BB1	CRC	E (2Rx8)	1G x8 * 16pcs	8Gb	B-die	16	2	78ball FBGA	30mm	MP	
2G x 64	16GB	M471A2K43BB1	CTD	E (2Rx8)	1G x8 * 16pcs	8Gb	C-die	16	2	78ball FBGA	30mm	MP	
2G x 64	16GB	M471A2K43CB1	CRC	E (2Rx8)	1G x8 * 16pcs	8Gb	C-die	16	2	78ball FBGA	30mm	MP	
2G x 64	16GB	M471A2K43CB1	CTD	E (2Rx8)	1G x8 * 16pcs	8Gb	C-die	16	2	78ball FBGA	30mm	MP	

4.6 288Pin DDR4 ECC UDIMM

288Pin DDR4 ECC UDIMM													
Org.	Density	Part Number	Temp & Power & Speed	Raw Card	Composition	Comp. Version		Internal Banks	Rank	PKG	Height	Avail.	NOTE
512M x72	4GB	M391A5143EB1	CPB	D (1Rx8)	512M x8 * 9pcs	4Gb	E-die	16	1	78ball FBGA	31.25mm	MP	
512M x72	4GB	M391A5143EB1	CRC	D (1Rx8)	512M x8 * 9pcs	4Gb	E-die	16	1	78ball FBGA	31.25mm	MP	
512M x72	4GB	M391A5143EB1	CTD	D (1Rx8)	512M x8 * 9pcs	4Gb	E-die	16	1	78ball FBGA	31.25mm	TBD	
1G x72	8GB	M391A1G43DB0	CPB	E (2Rx8)	512M x8 * 18pcs	4Gb	D-die	16	2	78ball FBGA	31.25mm	EOL 2Q'17	
1G x72	8GB	M391A1G43DB1	CRC	E (2Rx8)	512M x8 * 18pcs	4Gb	D-die	16	2	78ball FBGA	31.25mm	EOL 2Q'17	
1G x72	8GB	M391A1G43EB1	CTD	E (2Rx8)	512M x8 * 18pcs	4Gb	E-die	16	2	78ball FBGA	31.25mm	TBD	
1G x72	8GB	M391A1G43EB1	CPB	E (2Rx8)	512M x8 * 18pcs	4Gb	E-die	16	2	78ball FBGA	31.25mm	MP	
1G x72	8GB	M391A1G43EB1	CRC	E (2Rx8)	512M x8 * 18pcs	4Gb	E-die	16	2	78ball FBGA	31.25mm	MP	
1G x72	8GB	M391A1K43BB1	CPB	D (1Rx8)	1G x8 * 9pcs	8Gb	B-die	16	1	78ball FBGA	31.25mm	MP	
1G x72	8GB	M391A1K43BB1	CRC	D (1Rx8)	1G x8 * 9pcs	8Gb	B-die	16	1	78ball FBGA	31.25mm	MP	
1G x72	8GB	M391A1K43BB1	CTD	D (1Rx8)	1G x8 * 9pcs	8Gb	B-die	16	1	78ball FBGA	31.25mm	MP	
2G x72	16GB	M391A2K43BB1	CPB	E (2Rx8)	1G x8 * 18pcs	8Gb	B-die	16	2	78ball FBGA	31.25mm	MP	
2G x72	16GB	M391A2K43BB1	CRC	E (2Rx8)	1G x8 * 18pcs	8Gb	B-die	16	2	78ball FBGA	31.25mm	MP	
2G x72	16GB	M391A2K43BB1	CTD	E (2Rx8)	1G x8 * 18pcs	8Gb	B-die	16	2	78ball FBGA	31.25mm	TBD	

4.7 288Pin DDR4 Non ECC UDIMM

288Pin DDR4 Non ECC UDIMM													
Org.	Density	Part Number	Temp & Power & Speed	Raw Card	Composition	Comp. Version		Internal Banks	Rank	PKG	Height	Avail.	NOTE
256M x64	2GB	M378A5644EB0	CPB	A (1Rx16)	256M x16 * 8psc	4Gb	E-die	16	1	96ball FBGA	31.25mm	EOL	
256M x64	2GB	M378A5644EB0	CRC	C (1Rx16)	256M x16 * 8psc	4Gb	E-die	4	1	96ball FBGA	31.25mm	EOL	
512M x64	4GB	M378A5143DB0	CPB	A (1Rx8)	512M x8 * 8pcs	4Gb	D-die	16	1	78ball FBGA	31.25mm	EOL 1Q'17	
512M x64	4GB	M378A5143EB1	CPB	A (1Rx8)	512M x8 * 8pcs	4Gb	E-die	16	1	78ball FBGA	31.25mm	MP	
512M x64	4GB	M378A5143EB1	CRC	A (1Rx8)	512M x8 * 8pcs	4Gb	E-die	16	1	78ball FBGA	31.25mm	MP	
512M x64	4GB	M378A5244BB0	CPB	C (1Rx16)	512M x16 * 4psc	8Gb	B-die	16	1	78ball FBGA	31.25mm	MP	
512M x64	4GB	M378A5244BB0	CRC	C (1Rx16)	512M x16 * 4psc	8Gb	B-die	16	1	78ball FBGA	31.25mm	MP	
512M x64	4GB	M378A5244BB0	CTD	C (1Rx16)	512M x16 * 4psc	8Gb	B-die	16	1	78ball FBGA	31.25mm	MP	
512M x64	4GB	M378A5244CB0	CRC	C (1Rx16)	512M x16 * 4psc	8Gb	C-die	16	1	78ball FBGA	31.25mm	MP	
512M x64	4GB	M378A5244CB0	CTD	C (1Rx16)	512M x16 * 4psc	8Gb	C-die	16	1	78ball FBGA	31.25mm	MP	
1G x64	8GB	M378A1G43DB0	CPB	B (2Rx8)	512M x8 * 16pcs	4Gb	D-die	16	2	78ball FBGA	31.25mm	EOL 1Q'17	
1G x64	8GB	M378A1G43EB1	CPB	B (2Rx8)	512M x8 * 16pcs	4Gb	E-die	16	2	78ball FBGA	31.25mm	MP	
1G x64	8GB	M378A1G43EB1	CRC	B (2Rx8)	512M x8 * 16pcs	4Gb	E-die	16	2	78ball FBGA	31.25mm	MP	
1G x64	8GB	M378A1K43BB1	CPB	A (1Rx8)	1G x8 * 8pcs	8Gb	B-die	16	1	78ball FBGA	31.25mm	MP	
1G x64	8GB	M378A1K43BB2	CRC	A (1Rx8)	1G x8 * 8pcs	8Gb	B-die	16	1	78ball FBGA	31.25mm	MP	
1G x64	8GB	M378A1K43BB2	CTD	A (1Rx8)	1G x8 * 8psc	8Gb	B-die	16	1	78ball FBGA	31.25mm	MP	
1G x64	8GB	M378A1K43CB2	CRC	A (1Rx8)	1G x8 * 8psc	8Gb	C-die	16	1	78ball FBGA	31.25mm	MP	
1G x64	8GB	M378A1K43CB2	CTD	A (1Rx8)	1G x8 * 8psc	8Gb	C-die	16	1	78ball FBGA	31.25mm	MP	
2G x64	16GB	M378A2K43BB1	CPB	B (2Rx8)	1G x8 * 16pcs	8Gb	B-die	16	2	78ball FBGA	31.25mm	MP	
2G x64	16GB	M378A2K43BB1	CRC	B (2Rx8)	1G x8 * 16pcs	8Gb	B-die	16	2	78ball FBGA	31.25mm	MP	
2G x64	16GB	M378A2K43BB1	CTD	B (2Rx8)	1G x8 * 16psc	8Gb	B-die	16	2	78ball FBGA	31.25mm	MP	
2G x64	16GB	M378A2K43CB1	CRC	B (2Rx8)	1G x8 * 16psc	8Gb	C-die	16	2	78ball FBGA	31.25mm	MP	
2G x64	16GB	M378A2K43CB1	CTD	B (2Rx8)	1G x8 * 16psc	8Gb	C-die	16	2	78ball FBGA	31.25mm	MP	

5. RDIMM, LRDIMM Memory Buffer Information

5.1 Label Example

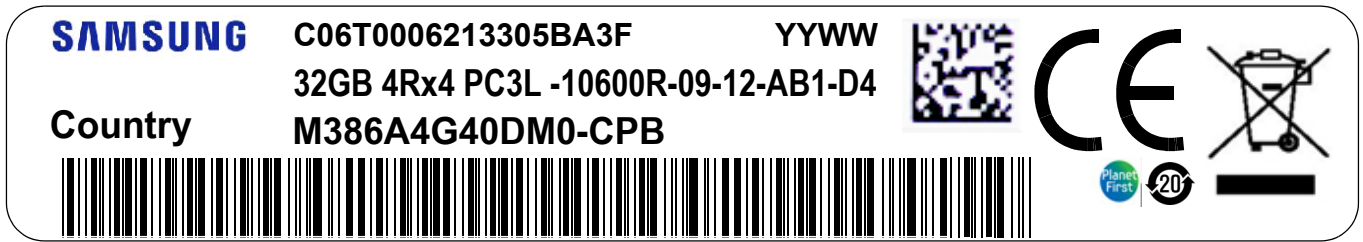

5.2 JEDEC Description Information

1. Module total capacity, in gigabytes, for primary bus (ECC not counted)
2. Number of package ranks of memory installed and number of logical ranks per package rank
3. Device organization (data bit width) of SDRAMs used on this assembly
4. SDRAM and support component supply voltage (VDD)
blank = 1.2 V operable
5. Module speed in Mb/s/data pin
6. SDRAM speed grade
7. Module Type
 E = Unbuffered DIMM ("UDIMM"), x64 primary + 8 bit ECC module data bus
 L = Load Reduced DIMM ("LRDIMM"), x64 primary + 8 bit ECC module data bus
 R = Registered DIMM ("RDIMM"), x64 primary + 8 bit ECC module data bus
 S = Small Outline DIMM ("SO-DIMM"), no ECC (x64 bit module data bus)
 U = Unbuffered DIMM ("UDIMM"), no ECC (x64 bit module data bus)
 T = Unbuffered 72-bit small outline DIMM ("72b-SO-DIMM"), x64 primary + 8bit ECC module data bus
8. Reference design file used for this design (if applicable)
 A = Reference design for raw card 'A' is used for this assembly
 B = Reference design for raw card 'B' is used for this assembly
 AC = Reference design for raw card 'AC' is used for this assembly (example only)
 ZZ = None of the JEDEC standard reference designs were used for this assembly
9. Revision number of the reference design used
 0 = Initial release
 1 = First revision
 2 = Second revision
 P = Pre-release or Engineering sample
 Z = To be used when reference raw card = ZZ
10. JEDEC SPD Revision Encoding and Additions level used on this DIMM

5.3 RCD (& Data Buffer) Information

(These codes are only used SAMSUNG, Not JEDEC)

11&12. RCD, Data Buffer Revision & Vendor used on this DIMM

Jedec Description on label	Buffer Vendor	RCD ver	DB ver (Only LRDIMM)
DC0	IDT	C0	B1
MB1	Montage	B1	A1
P20	Inphi	GS02	GS01
MC0	Montage	C0	B0
DC3	IDT	C0	A3
MA0	Montage	A0	A1
DB0	IDT	B0	B0
PA0	Inphi	A0	A0

6. Package Dimension

78ball FBGA for

4Gb D-die (x4/x8) / DDP 8Gb D-die (x4) / 4H 16Gb D-die (x4)

4Gb E-die (x4/x8)

8Gb B-die (x4/x8) / DDP 16Gb B-die (x4) / 2H 16Gb B-die (x4) / 4H 32Gb B-die (x4)

8Gb C-die (x4/x8)

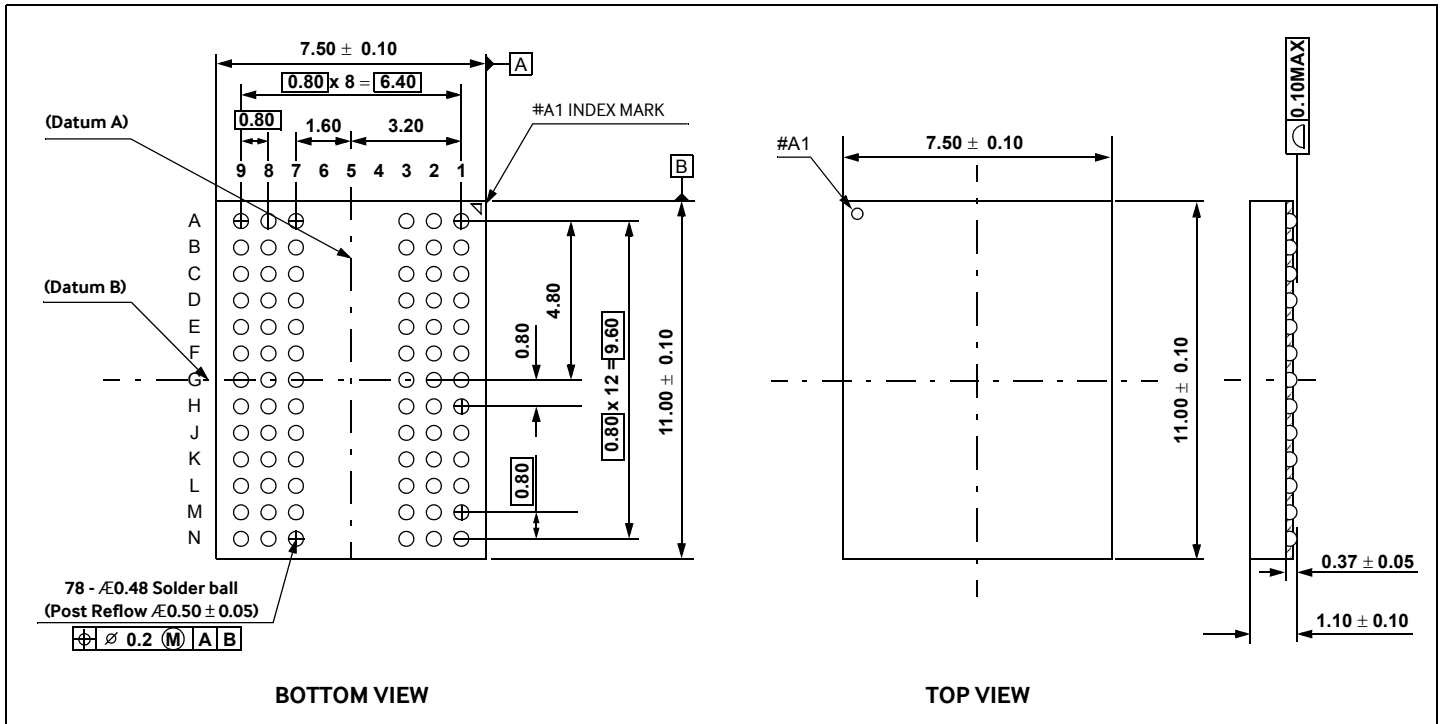

96ball FBGA for

4Gb D-die (x16) / 4Gb E-die (x16)

8Gb B-die (x16) / 8Gb C-die (x16)

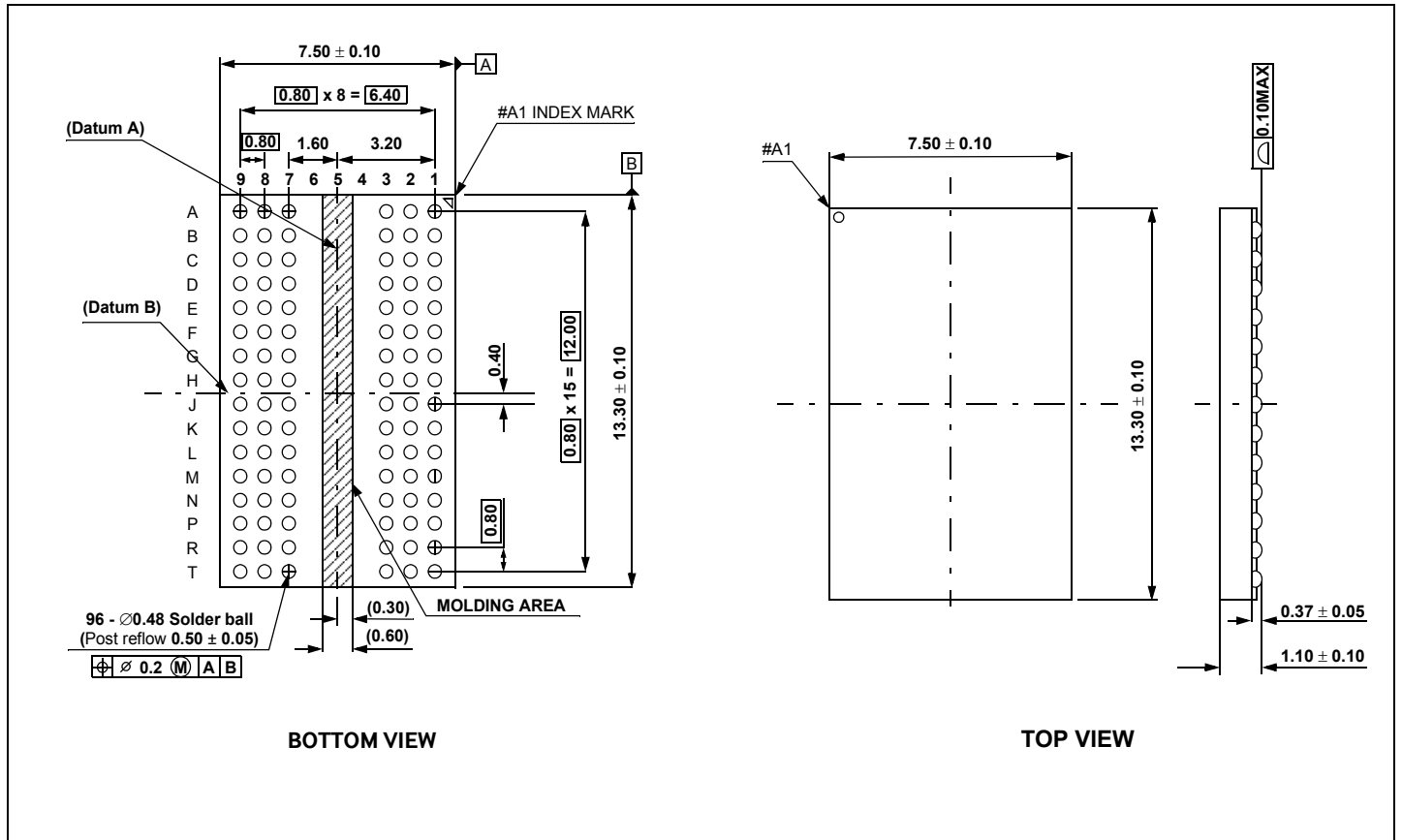

7. Module Dimension

- x72 288pin DDR4 SDRAM RDIMM
- x72 288pin DDR4 SDRAM LRDIMM
- x72 288pin DDR4 SDRAM ECC UDIMM
- x64 288pin DDR4 SDRAM Non ECC UDIMM

Units : Millimeters

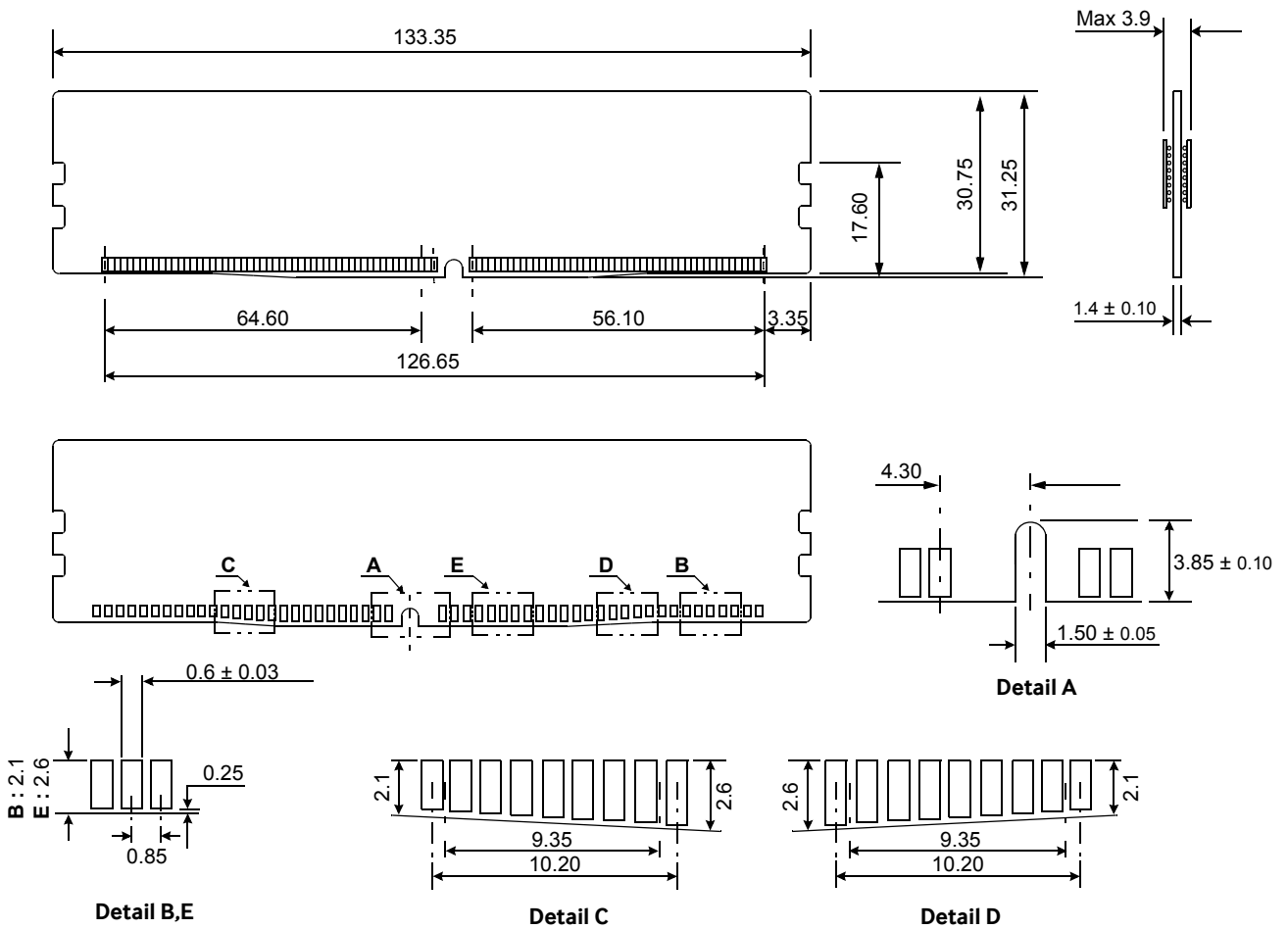

x72 260pin DDR4 SDRAM ECC SODIMM
x64 260pin DDR4 SDRAM Non ECC SODIMM

Units : Millimeters

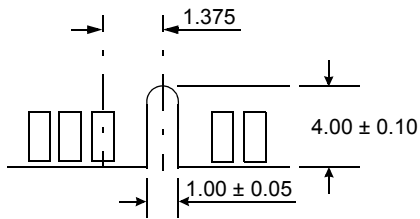
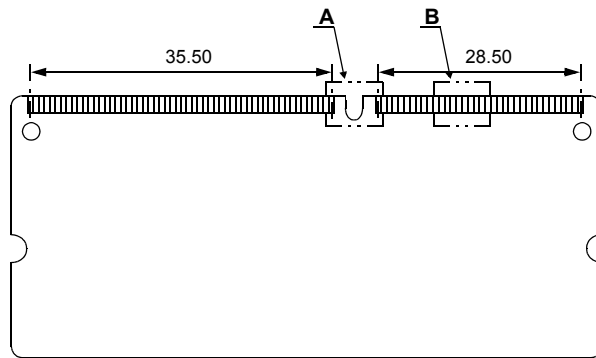
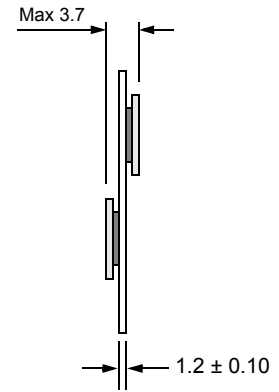
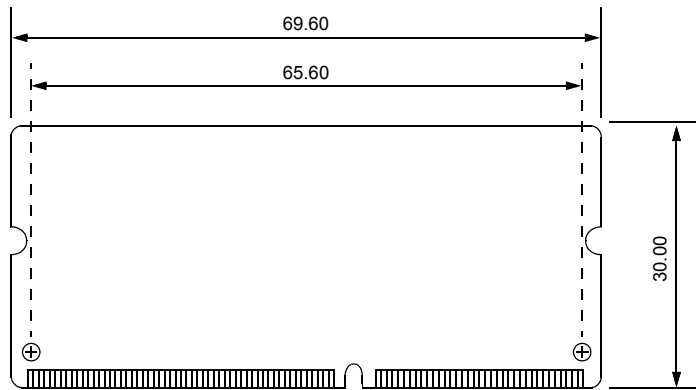

Detail A

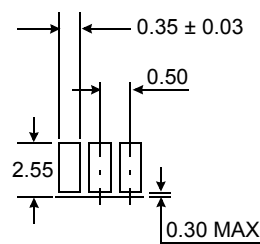

Detail B

x72 288pin DDR4 SDRAM VLP RDIMM

Units : Millimeters

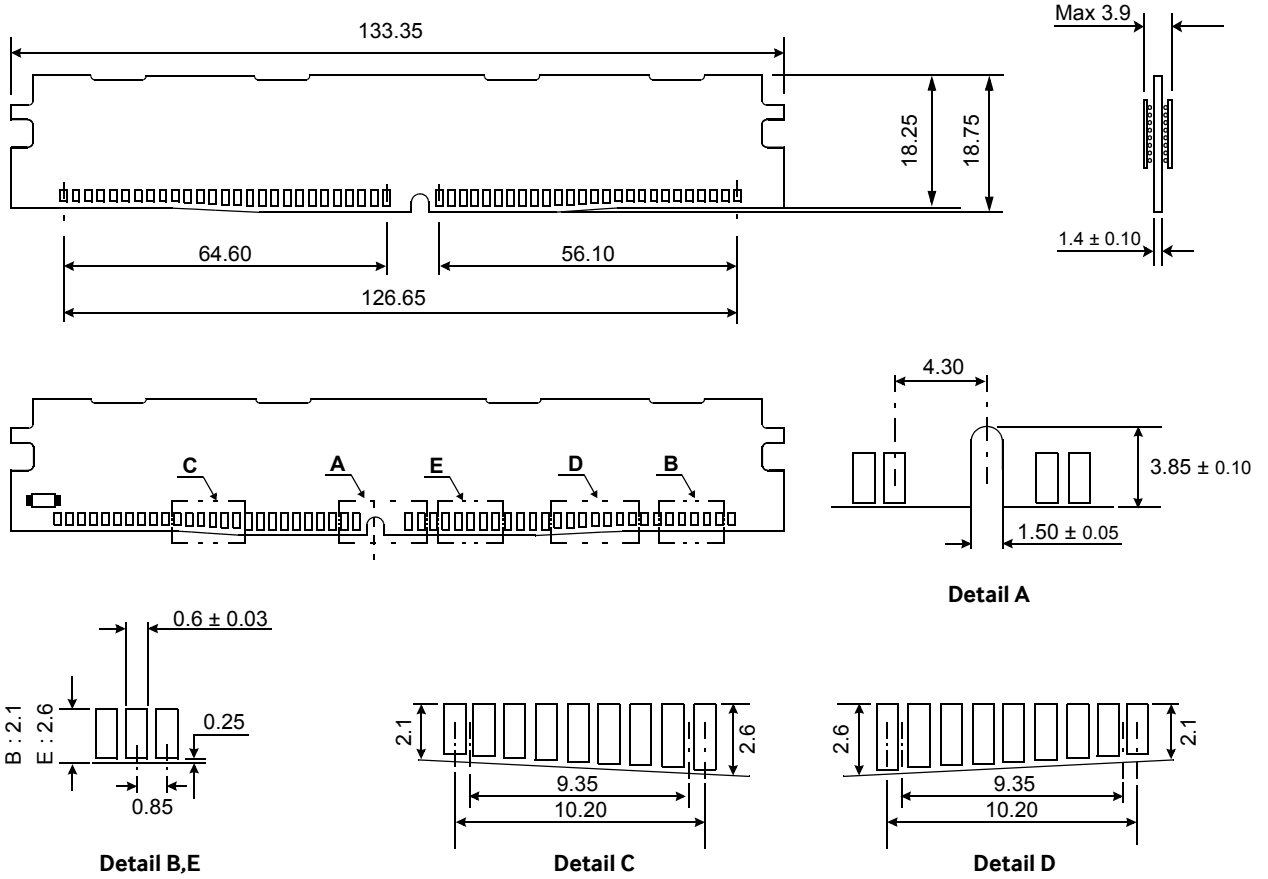

x72 288pin DDR4 SDRAM VLP RDIMM Heat Spreader Design Guide (DDP)

1. FRONT

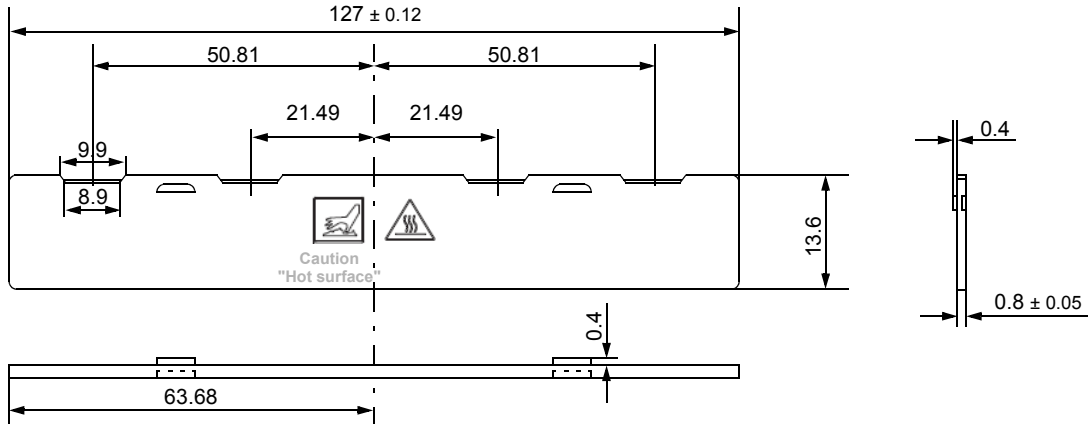

2. BACK

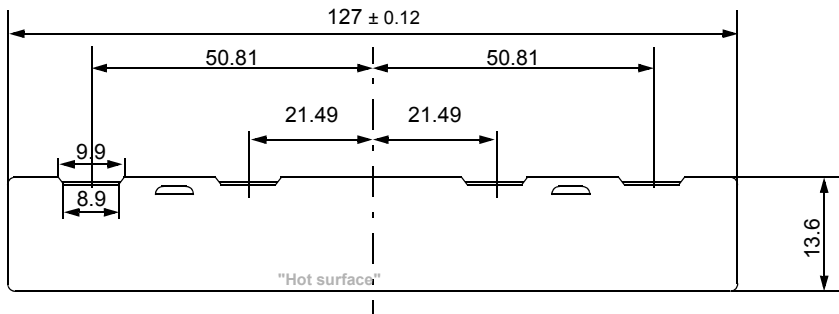

3. CLIP

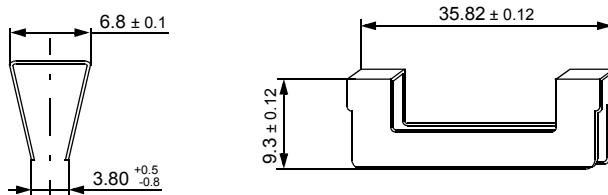

x72 288pin DDR4 SDRAM RDIMM Heat Spreader Design Guide (TSV)

1. FRONT PART

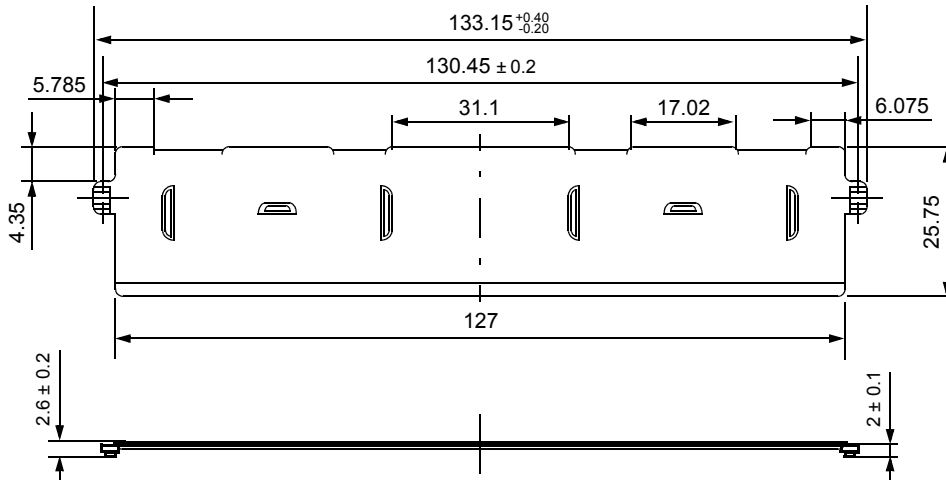

2. BACK PART

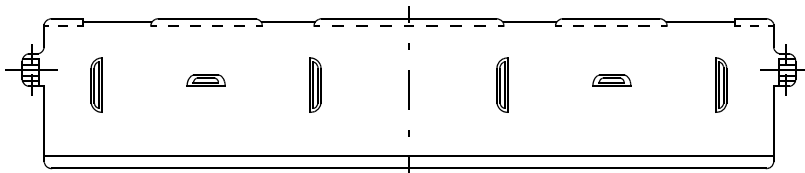

3. CLIP PART

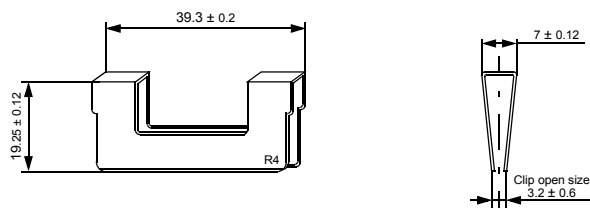

x72 288pin DDR4 SDRAM LRDIMM Heat Spreader Design Guide (DDP)

1. FRONT PART

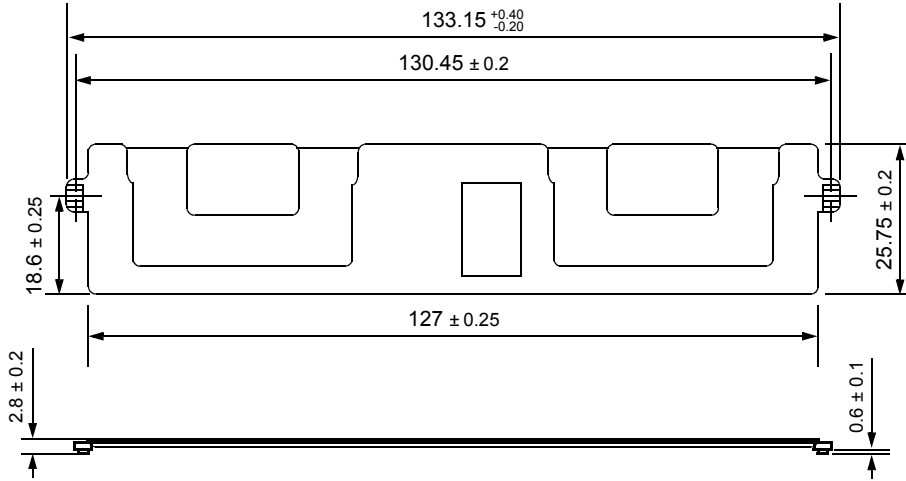

2. BACK PART



3. CLIP PART

